



# Instruction Manual

## Condiment Warmers

Model No. 2191, 2191EX, 2195, 2195EX, 2196,  
2200, 2200EX, 2205, 2205EX



**GOLD MEDAL® PRODUCTS CO.**

10700 Medallion Drive, Cincinnati, Ohio 45241-4807 USA



# Table of Contents

**SAFETY PRECAUTIONS ..... 3**

**INSTALLATION INSTRUCTIONS ..... 5**

    Inspection of Shipment ..... 5

    Manual ..... 5

    Setup ..... 5

    Electrical Requirements ..... 6

    Before You Plug In Machine ..... 6

**OPERATING INSTRUCTIONS ..... 7**

    Controls and Their Functions ..... 7

    Operating Instructions ..... 7

**Care and Cleaning ..... 8**

        Clean and Sanitize the Pump Assembly (if equipped) ..... 8

        Cleaning the Unit ..... 8

**Pump Assembly ..... 9**

**MAINTENANCE INSTRUCTIONS ..... 11**

**ORDERING SPARE PARTS ..... 12**

    Cabinet Exterior – Parts Breakdown ..... 13

    Cabinet Exterior – Parts List ..... 14

    Cabinet Exterior and Bottom View ..... 15

    Pump – Dipper – Inserts – Replacement Parts ..... 16



    Pump Assembly 38037 ..... 17



**Wiring Diagram ..... 18**



**WARRANTY ..... 19**







# SAFETY PRECAUTIONS

	 <b>DANGER</b>
	<p>Machine must be properly grounded to prevent electrical shock to personnel. Failure to do so could result in serious injury, or death. DO NOT immerse any part of this equipment in water. DO NOT use excessive water when cleaning. Keep cord and plug off the ground and away from moisture. Always unplug the equipment before cleaning or servicing. Make sure all machine switches are in the OFF position before plugging the equipment into the receptacle.</p> <p style="text-align: right; font-size: small;">008_051514</p>

	 <b>DANGER</b>
	<p>Improper installation, adjustment, alteration, service, or maintenance can cause property damage, injury, or death. Any alterations to this equipment will void the warranty and may cause a dangerous condition. This appliance is not intended to be operated by means of an external timer or separate remote-control system. NEVER make alterations to this equipment. Read the Installation, Operating, and Maintenance Instructions thoroughly before installing, servicing, or operating this equipment.</p> <p style="text-align: right; font-size: small;">014_020416</p>



	 <b>WARNING</b>
	<p>To avoid burns, DO NOT touch heated surfaces. DO NOT place or leave objects in contact with heated surfaces.</p> <p style="text-align: right; font-size: small;">009_092414</p>



	 <b>WARNING</b>
	<p>ALWAYS wear safety glasses when servicing this equipment.</p> <p style="text-align: right; font-size: small;">010_010914</p>

	 <b>WARNING</b>
	<p>No user serviceable parts inside. Refer servicing to qualified service personnel.</p> <p style="text-align: right; font-size: small;">011_051514</p>

	 <b>WARNING</b>
	<p>Read and understand operator's manual and all other safety instructions before using this equipment. To order copies of the operator's manual go to <a href="http://gmpopcorn.com">gmpopcorn.com</a> or write to Gold Medal Products Co., 10700 Medallion Drive, Cincinnati, OH 45241 USA 1-(800)-543-0862</p> <p style="text-align: right; font-size: small;">022_060215</p>



	 <b>WARNING</b>
	DO NOT allow direct contact of this equipment by the public when used in food service locations. Only personnel trained and experienced in the equipment operation may operate this equipment. Carefully read all instructions before operation. <span style="float: right;">012_010914</span>

	 <b>WARNING</b>
	This machine is NOT to be operated by minors. <span style="float: right;">007_010914</span>

This appliance is not intended for use by persons (including children) with reduced physical, sensory or mental capabilities, or lack of experience and knowledge, unless they have been given supervision or instruction concerning use of the appliance by a person responsible for their safety.

**Note:** Improvements are always being made to Gold Medal’s equipment. This information may not be the latest available for your purposes. It is critical that you call Gold Medal’s Technical Service Department at 1-800-543-0862 for any questions about your machine operations, replacement parts, or any service questions. (Gold Medal Products Co. does not assume any liability for injury due to careless handling and/or reckless operation of this equipment.) General images may be used in manual for reference only.



---

# INSTALLATION INSTRUCTIONS

## Inspection of Shipment

After unpacking, check thoroughly for any damage which may have occurred in transit. Claims should be filed immediately with the transportation company. The warranty does not cover damage that occurs in transit, or damage caused by abuse, or consequential damage due to the operation of this machine, since it is beyond our control (reference warranty in back of manual).

## Manual

Read and understand the operator's manual and all other safety instructions before using this equipment. To order copies of the operator's manual go to [gmpopcorn.com](http://gmpopcorn.com) or write to Gold Medal Products Co., 10700 Medallion Drive, Cincinnati, OH 45241 USA 1-(800)-543-0862.

## Setup

Remove all packing material and tape before starting operation. This warmer is designed to use a standard No. 10 tin that your product came in as the insert Bowl. An optional stainless steel insert bowl is available, Gold Medal Part No. 2194.

1. Remove all packaging and tape prior to operation.
2. Place unit on a sturdy, level base for use.
3. After setup, the unit should be cleaned prior to use (see Care and Cleaning section of this manual).





## Electrical Requirements

The following power supply must be provided (reference unit Data Plate for Wattage requirement):

**Domestic Series (2191, 2195, 2196, 2200, 2205):** 120 V~, 60 Hz

**Export Series (2191EX, 2195EX, 2196EX, 2200EX, 2205EX):** 220-230 V~, 50/60 Hz



Potential Electrical Variations: 220 V~, 60 Hz

	 <b>DANGER</b>
	<p>Machine must be properly grounded to prevent electrical shock to personnel. Failure to do so could result in serious injury, or death.                  DO NOT immerse any part of this equipment in water.                  DO NOT use excessive water when cleaning.                  Keep cord and plug off the ground and away from moisture.                  Always unplug the equipment before cleaning or servicing.                  Make sure all machine switches are in the OFF position before plugging the equipment into the receptacle.</p> <p style="text-align: right; font-size: small;">008_051514</p>

A certified electrician must furnish sufficient power for proper machine operation and install any supplied receptacle (reference unit Data Plate for model specific Volts AC, Hertz, and Wattage requirements). We recommend this equipment be on a dedicated and protected circuit. Failure to wire properly will void the warranty and may result in damage to the machine. It is Gold Medal Products Co.'s recommendation that this machine be plugged directly into a wall outlet. The use of extension cords is not recommended due to safety concerns, and may cause sacrificed and/or reduced performance. Make sure cord is located to prevent a trip hazard or unit upset. Units with an IEC Power Cord - make sure the IEC cord is properly seated into the IEC receptacle before powering up the machine.

## Before You Plug In Machine

1. Make sure all machine switches are OFF before plugging equipment into receptacle.
2. Make sure wall outlet can accept the grounded plugs (where applicable) on the power supply cord.
3. The wall outlet must have the proper polarity. If in doubt, have a competent electrician inspect the outlet and correct if necessary.
4. **DO NOT** use a grounded to un-grounded receptacle adapter (where applicable).
5. Install unit in a level position.

	 <b>CAUTION</b>
	<p>If the supply cord is damaged, it must be replaced by Gold Medal Products Co., its service agent or similarly qualified persons in order to avoid a hazard.</p> <p style="text-align: right; font-size: small;">039_080614</p>

# OPERATING INSTRUCTIONS

## Controls and Their Functions

### POWER SWITCH

ON/OFF Power Switch – supplies power to the unit.

### HEAT CONTROL KNOB

Controls the heat element for the warmer.

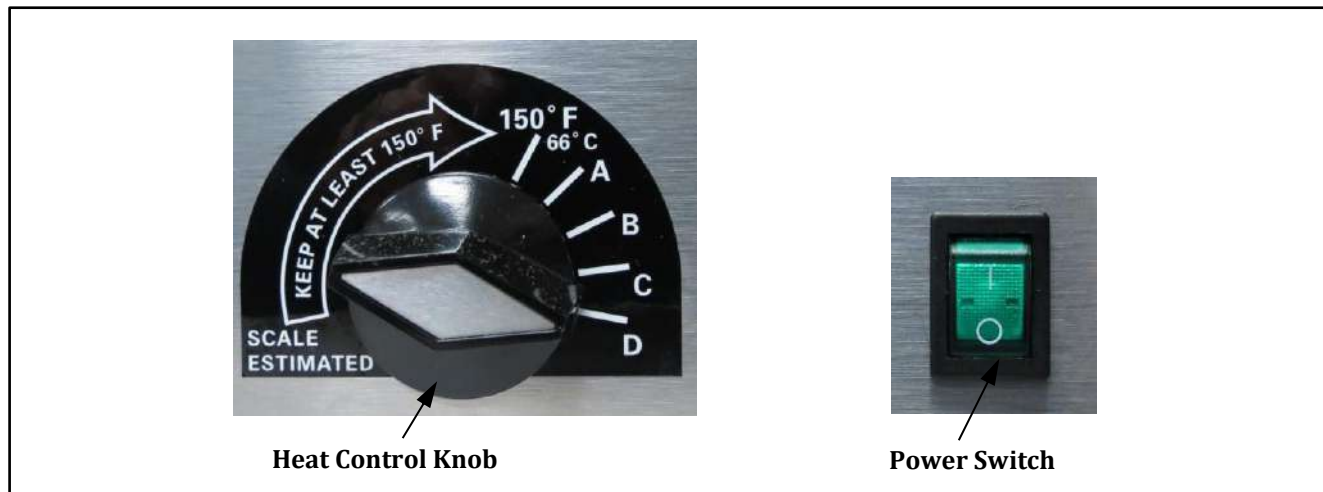

## Operating Instructions

1. Place platform (can holder/bowl spring, if provided) in water tank.
2. Fill water well with 5 cups of water (starting with hot water helps shorten warming time).  
**DO NOT operate the warmer without water in the well.**
3. Carefully place No. 10 Tin or insert bowl of product into the unit (platform/bowl spring should be centered under the container).  
**Note:** On pump models, contents must be preheated before inserting. The pump will not function if contents are too thick.
4. Place lock ring or pump over container, press down and turn until it locks into unit.
5. Turn the power switch ON.
6. Set the Heat Control on HI (“D” setting). Once product is heated, reduce the heat (stir as needed depending on product).

**Caution:** Prolonged heating on HI could result in overcooking.

For cheese product, keep the Heat Control setting at least 150°F to hold a safe cheese product temperature. Let the cheese heat for 1 to 1½ hours (stirring every 15 minutes) before serving. The pump works best when the cheese is hot.

7. Turn the Power Switch OFF when the unit is not in use.

## Care and Cleaning

	<b>⚠ DANGER</b>
	<p>Machine must be properly grounded to prevent electrical shock to personnel. <b>DO NOT immerse in water.</b> DO NOT clean appliance with a water jet. Always unplug the equipment before cleaning or servicing.</p> <p style="text-align: right;">025_111616</p>

	<b>⚠ WARNING</b>
	<p>To avoid burns, DO NOT touch heated surfaces. DO NOT place or leave objects in contact with heated surfaces.</p> <p style="text-align: right;">009_092414</p>

Good sanitation practice demands that all food preparation equipment be cleaned regularly (only use non-toxic, food grade cleaners). A clean looking, well-kept machine is one of the best ways of advertising your product.

For surfaces needing further cleaning or degreasing, Watchdog Stainless Cleaner (Item No. 2088) or Watchdog Concession Equipment Degreaser (Item No. 2580) is available for use accordingly. For any cleaning products used, follow the manufacturer's instructions on the product. **DO NOT use oven cleaners or abrasive materials** as they will damage parts of machine.

### Clean and Sanitize the Pump Assembly (if equipped)

1. Turn machine OFF, unplug the unit and allow it to cool before attempting to clean.
2. Remove pump assembly from can or bowl and take it to the sink to clean.
3. Disassemble lid and pump components (reference instructions in next section).
4. Wash lid and pump parts using warm soapy water—use a tube brush to clean the pump body and discharge tube interior, then rinse all parts with clean hot water.
5. Sanitize all parts with sanitizing solution—make sure it flows through tubing, Gold Medal's Chlor-Tech (Item No. 1109) is recommended, then allow parts to air dry.
6. Reassemble pump and lid for use.

### Cleaning the Unit

1. Turn machine OFF, unplug the unit and allow it to cool before attempting to clean.
2. Remove all pans/accessories and take them to the sink to clean with soap and water, then rinse and dry.
3. Empty the well contents.
4. Wipe unit surfaces using a clean, SLIGHTLY damp cloth (cloth may be SLIGHTLY dampened with soap and water, then wipe again with clean water to remove any remaining cleaner).

Ammonia cleaners will damage plastic panels. Only use a non-ammonia cleaner, such as Gold Medal Watchdog Glass Cleaner (Item No. 2588).





# Pump Assembly

## Pump Assembly (38037)

(Disassemble in reverse order.)

**Step 1:** Put lid on pump body—screw on lid bushing to fasten lid.

**Step 2:** Insert square shaft w/bottom plate—**o-ring MUST be in place on plate.**

**Step 3:** Place assembly on edge of counter for support.

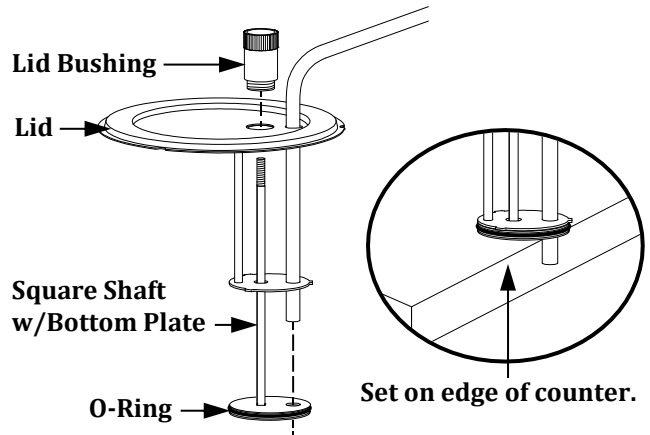

**Step 4:** Place spring onto shaft.

**Step 5:** Place knob support on shaft over spring.

**Important:** Inner cutout of support **MUST go over square shaft** or amount dispensed per pump cannot be adjusted.

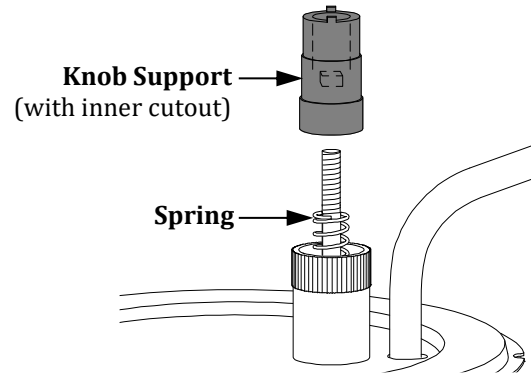
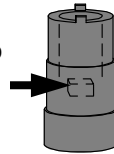

**Step 6:** Compress support to see threads, then screw knob onto shaft.

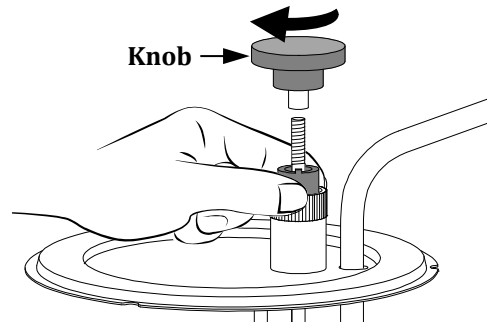

## Step 7: Set Amount Dispensed per Pump

Amount dispensed is determined by how far the knob is screwed on.

- Leave maximum threads showing on shaft for a maximum pump amount.
- Screw knob on fully for a minimum pump amount.

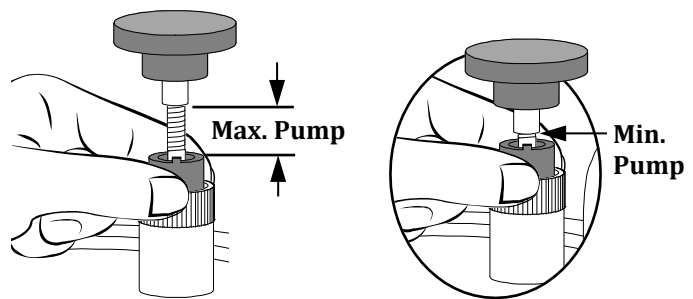



**Step 8: Release support—check placement:**

- A. **Check**—support **must** lock into knob (twist knob slightly if needed).
- B. **Check height**—bottom rib **must** rest in bushing.

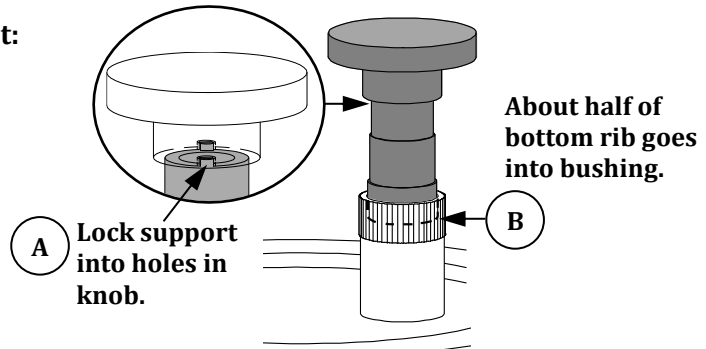

**Step 9: Assemble basin.**

- A. Put washer in basin.
- B. Install basin on pump body.
- C. Twist basin to lock it in place.

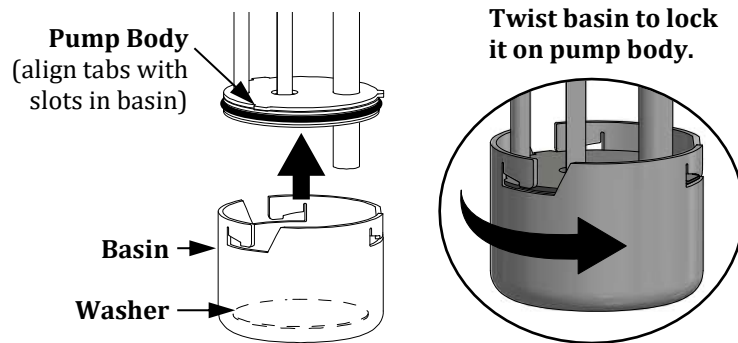

**Step 10: Install plug.**

- A. Align groove in plug with notch in dispense tube.
- B. Insert plug **completely**, then twist plug to lock it in place—**o-ring MUST be on plug**.

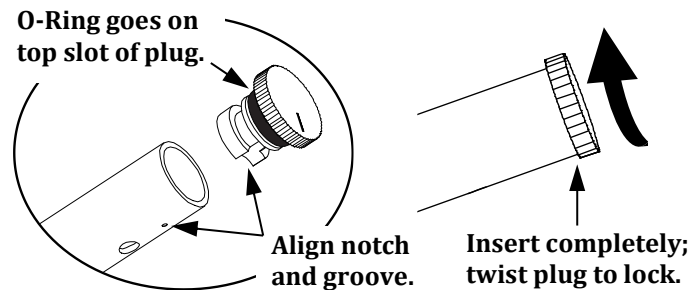



**Checking the Assembled Pump**

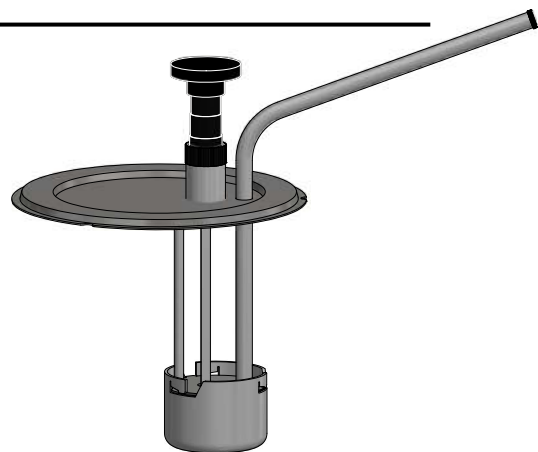

- **Support spins—cannot adjust pump amount:** Support cutout not fitted over square shaft (Step 5).
- **Knob turns after height is set:** Lock knob onto support (Step 8).
- **Knob stays depressed:** Shaft bottom plate catches tube end—knob not screwed on far enough (re-adjust bottom plate on tube, also see Step 8).
- **Support catches on lid bushing** – knob not screwed on enough to hold support in bushing (Step 8).







# MAINTENANCE INSTRUCTIONS

	 <b>DANGER</b>
	<p>Machine must be properly grounded to prevent electrical shock to personnel. Failure to do so could result in serious injury, or death.  <b>DO NOT</b> immerse any part of this equipment in water.  <b>DO NOT</b> use excessive water when cleaning.                      Keep cord and plug off the ground and away from moisture.                      Always unplug the equipment before cleaning or servicing.                      Make sure all machine switches are in the OFF position before plugging the equipment into the receptacle.</p> <p style="text-align: right; font-size: small;">008_051514</p>

	 <b>DANGER</b>
	<p>Improper installation, adjustment, alteration, service, or maintenance can cause property damage, injury, or death. Any alterations to this equipment will void the warranty and may cause a dangerous condition. This appliance is not intended to be operated by means of an external timer or separate remote-control system. <b>NEVER</b> make alterations to this equipment. Read the Installation, Operating, and Maintenance Instructions thoroughly before installing, servicing, or operating this equipment.</p> <p style="text-align: right; font-size: small;">014_020416</p>

	 <b>WARNING</b>
	<p>No user serviceable parts inside. Refer servicing to qualified service personnel.</p> <p style="text-align: right; font-size: small;">011_051514</p>

	 <b>CAUTION</b>
	<p>THE FOLLOWING SECTIONS OF THIS MANUAL ARE INTENDED ONLY FOR QUALIFIED SERVICE PERSONNEL WHO ARE FAMILIAR WITH ELECTRICAL EQUIPMENT. THESE ARE NOT INTENDED FOR THE OPERATOR.</p> <p style="text-align: right; font-size: small;">027_010914</p>



---

---

## ORDERING SPARE PARTS

1. Identify the needed part by checking it against the photos, illustrations, and/or parts list. (General images may be used in manual for reference only.)
2. Use only approved replacement parts when servicing this unit.
3. When ordering, please include part number, part name, and quantity needed.
4. Please include your model number, serial number, and date of manufacture (located on the machine nameplate/data plate) with your order.
5. Address all parts orders to Parts Department, Gold Medal Products Co., 10700 Medallion Drive, Cincinnati, Ohio 45241-4807

or place orders by phone or online:

Phone: (800) 543-0862  
(513) 769-7676

Fax: (800) 542-1496  
(513) 769-8500

E-mail: [info@gmpopcorn.com](mailto:info@gmpopcorn.com)  
Web Page: [gmpopcorn.com](http://gmpopcorn.com)

## Cabinet Exterior – Parts Breakdown



**1**

**2 (Sign Cover)**  
**3 (Acrylic Front)**

For Sign Graphic,  
reference images  
below.



**4** **5** **6** **7** **8\***



**9**



**10** **11** **12** **13**



PN 38211



PN 38213



PN 38745



PN 38212



PN 38214

**\*CAUTION:** If supply cord is damaged, it must be replaced by Gold Medal Products Co., its service agent, or similarly qualified persons in order to avoid a hazard.

**Sign View**



## Cabinet Exterior – Parts List

Item	Part Description	Part Number	
		2191, 2195, 2196, 2200, 2205	2191EX, 2195EX, 2200EX, 2205EX
1	CABINET ASSEMBLY	38025	38025
2	LEXAN SIGN COVER	38215	38215
3	ACRYLIC FRONT SIGN	38217	38217
4	TEMPERATURE SCALE	38303	38303
5	KNOB HEAT CONTROL	87049	87049
6	DPST ROCKER SWITCH	42532	42532
7	STRAIN RELIEF	76026	44073
8*	LEAD-IN CORD	22038	42369
9	WATER TANK ASSEMBLY	38029	38029
10	RUBBER BUMPER/FOOT	87247	87247
11	BOTTOM PLATE	38011	38011
12	SIGN RETAINER STRIP	38010	38010
13	10-24 X 3/8 SLOT HWH T23	38085	38085



## Cabinet Exterior and Bottom View

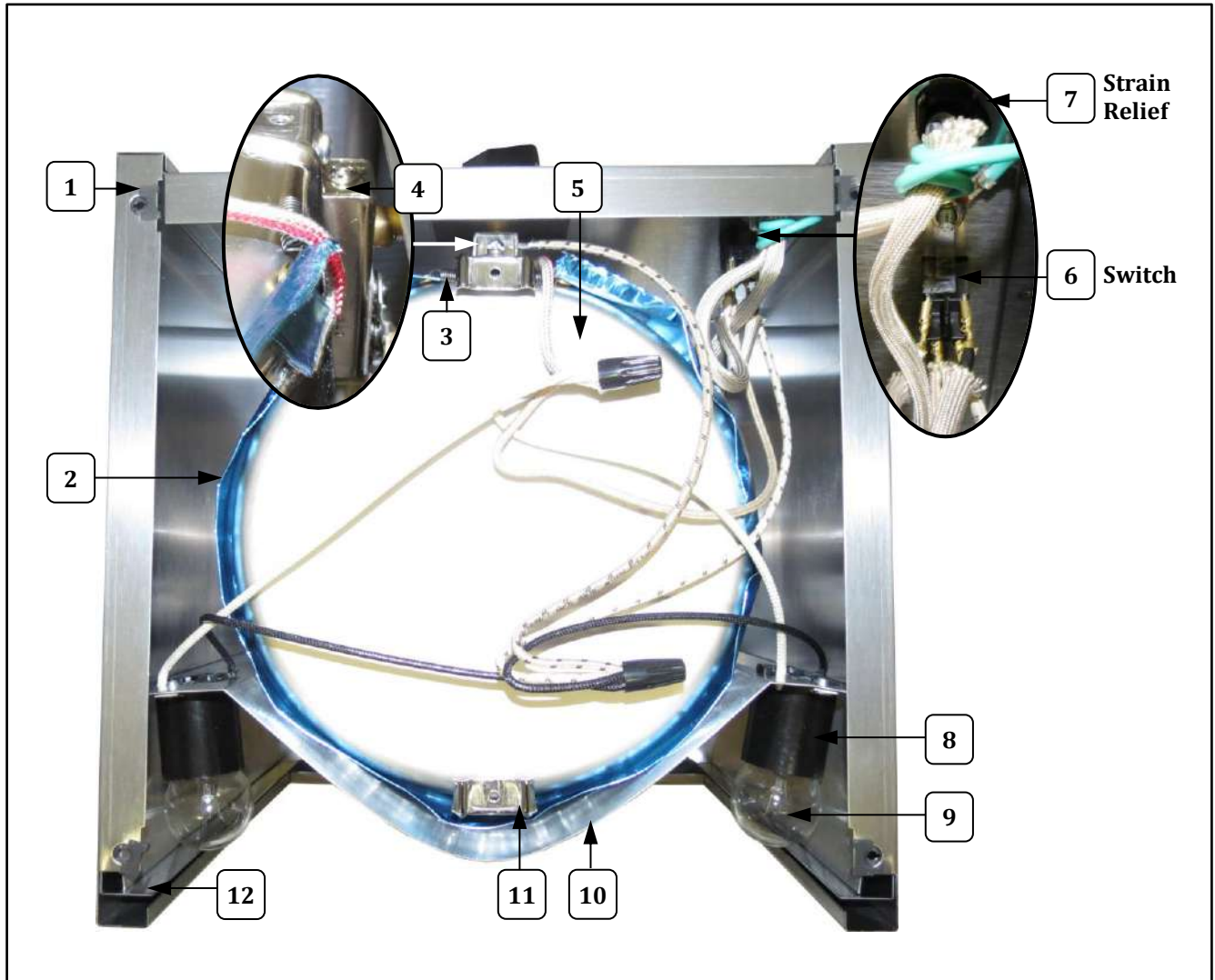

Item	Part Description	Part Number	
		2191, 2195, 2196, 2200, 2205	2191EX, 2195EX, 2200EX, 2205EX
1	#8-32 TINNEMAN FASTENER	47300	47300
2	HEAT ELEMENT	38012	38074
3	ELEMENT SPRING	38033	38033
4	210°F THERMOSTAT	38227	38227
5	WATER TANK ASSEMBLY	38029	38029
6	DPST ROCKER SWITCH	42532	42532
7	STRAIN RELIEF	76026	76026
8	INCANDESCENT LAMPHOLDER	75040	75040
9	LIGHT BULB CLEAR	47422	47422EX
10	BAFFLE	38044	38044
11	RETAINING CLIP	38030	38030
12	SIGN RETAINER ANGLE	38028	38028



## Pump – Dipper – Inserts – Replacement Parts

Items included varies by model.

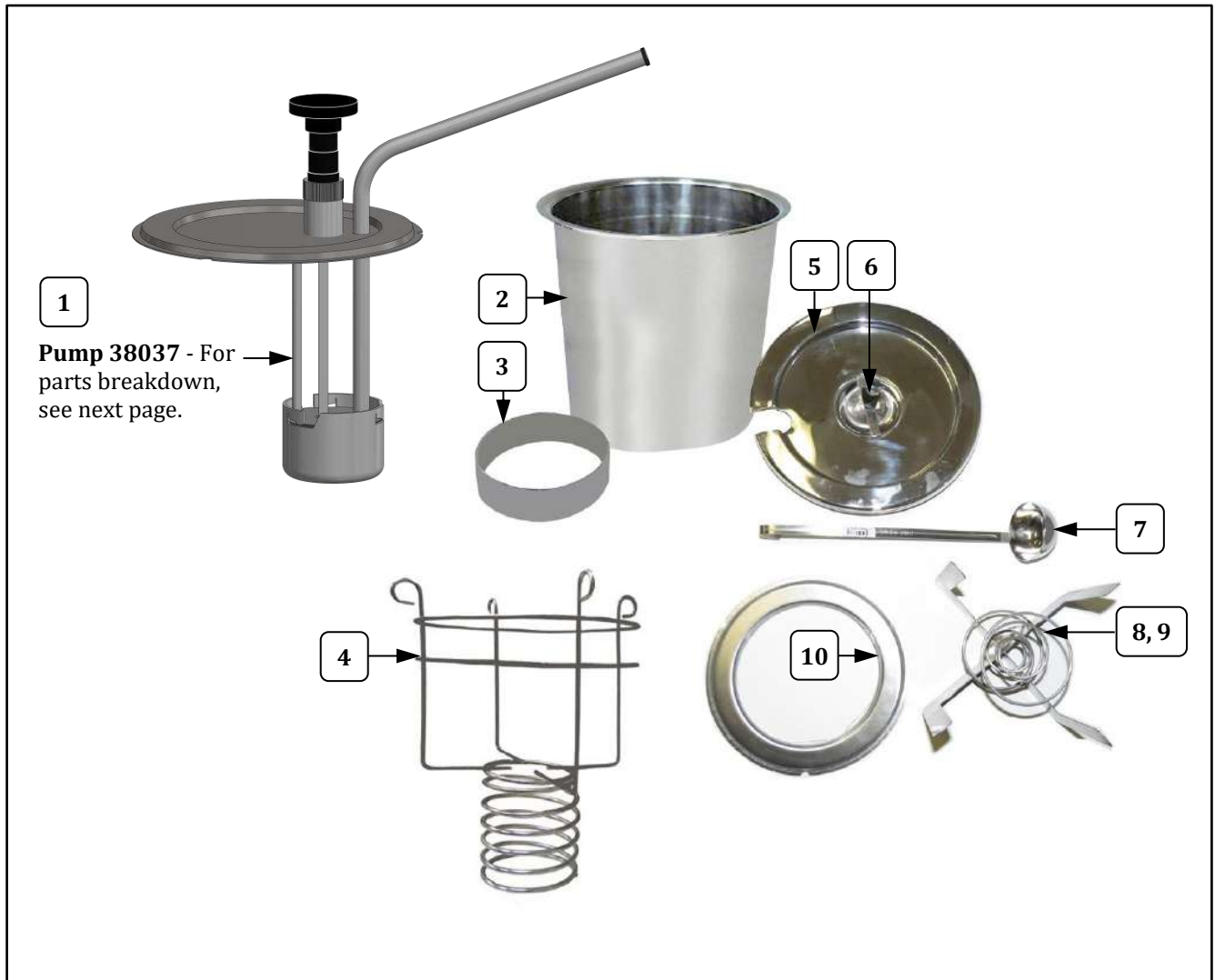

Item	Part Description	Part Number
1	PUMP ASSEMBLY	38037
2	133 OZ INSERT BOWL	2194
3	BOWL PLATFORM 1 1/16 IN	38120
4	WIRE BASKET SPRING LOADED	38096
5	LID ASSEMBLY WITH KNOB (assembly)	38042
6	KNOB (knob only)	47120
7	2 OZ DIPPER	38015
8	CAN HOLDER WITH SPRING (assembly)	38540
9	BOWL SPRING (spring only)	38022
10	LOCK RING	38031





# Pump Assembly 38037

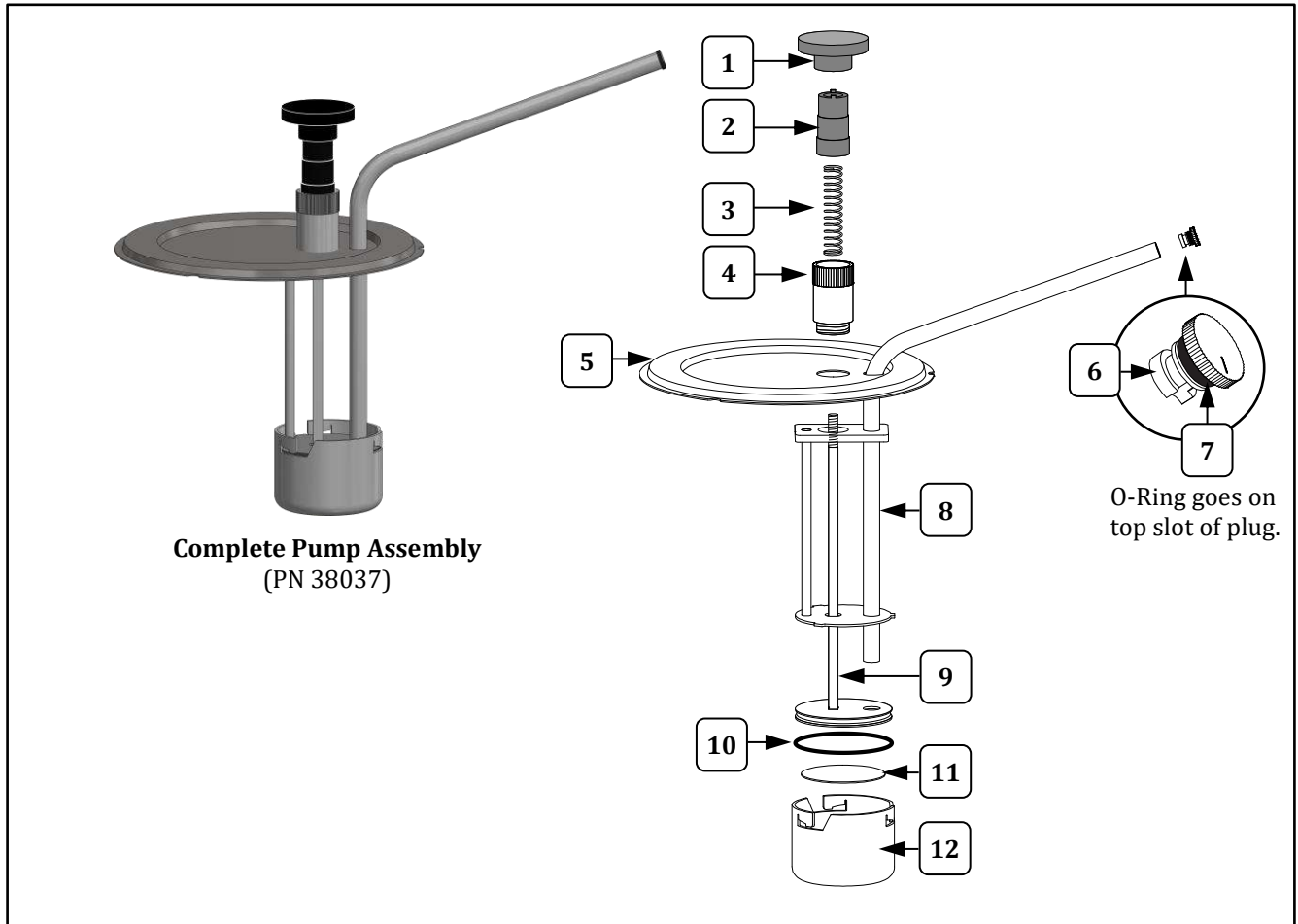

Item	Part Description	Part Number
		38037
1	PUMP KNOB	116395
2	KNOB SUPPORT	116391
3	KNOB SPRING	116390
4	LID BUSHING	116394
5	MOUNTING LID, PUMP	38038
6	PUMP PLUG	116392
7	O-RING (for pump plug)	116393
8	PUMP BODY WELDMENT	116398
9	BOTTOM PLATE WELDMENT (w/square shaft)	116397
10	O-RING (for bottom plate)	116600
11	WASHER	116309
12	PUMP BASIN	116308





## WARRANTY

Gold Medal Products Co. warrants to the original purchaser each item of its manufacture to be free of defects in workmanship and material under normal use and service. Gold Medal Products Co.'s obligation under this warranty is limited solely to repairing or replacing parts, f.o.b. Cincinnati, Ohio, which in its judgment are defective in workmanship or material and which are returned, freight prepaid, to its Cincinnati, Ohio factory or other designated point. Except for "Perishable Parts" on specific machines, the above warranty applies for a period of two (2) years from the date of original sale to the original purchaser of equipment when recommended operating instructions and maintenance procedures have been followed. These are packed with the machine. Parts warranty is two (2) years, labor is six (6) months.

THIS WARRANTY IS IN LIEU OF ALL OTHER WARRANTIES EXPRESSED OR IMPLIED, AND OF ALL OTHER OBLIGATIONS OR LIABILITIES ON OUR PART, INCLUDING THE IMPLIED WARRANTY OF MERCHANTABILITY. THERE ARE NO WARRANTIES WHICH EXTEND BEYOND THE DESCRIPTION ON THE FACE HEREOF. In no event shall Gold Medal Products Co. be liable for special, incidental or consequential damages. No claim under this warranty will be honored if the equipment covered has been misused, neglected, damaged in transit, or has been tampered with or changed in any way. No claim under this warranty shall be honored in the event that components in the unit at the time of the claim were not supplied or approved by Gold Medal Products Co. This warranty is effective only when electrical items have been properly attached to city utility lines only at proper voltages. This warranty is not transferable without the written consent of Gold Medal Products Co.

The term "Original Purchaser" as used in this warranty shall be deemed to mean that person, firm, association, or corporation who was billed by the GOLD MEDAL PRODUCTS CO., or their authorized distributor for the equipment.

THIS WARRANTY HAS NO EFFECT AND IS VOID UNLESS THE ORIGINAL PURCHASER FIRST CALLS GOLD MEDAL PRODUCTS CO. AT 1-800-543-0862 TO DISCUSS WITH OUR SERVICE REPRESENTATIVE THE EQUIPMENT PROBLEM, AND, IF NECESSARY, FOR INSTRUCTIONS CONCERNING THE REPAIR OR REPLACEMENT OF PARTS.

*NOTE: This equipment is manufactured and sold for commercial use only.*



**GOLD MEDAL® PRODUCTS CO.**

10700 Medallion Drive, Cincinnati, Ohio 45241-4807 USA

[gmpopcorn.com](http://gmpopcorn.com)

Phone: (800) 543-0862      Fax: (800) 542-1496  
(513) 769-7676              (513) 769-8500