

# Instruction Manual



## Self-serving Popcorn Dispenser

Model No. ZSX-98



**XFD XIAMEN MACHINERY AND TECHNOLOGY LTD**



---



No.58 TongMing Road, TongAn District, XiaMen City, China



# Table of Contents



<b>SAFETY PRECAUTIONS .....</b>	<b>3</b>
<b>INSTALLATION INSTRUCTIONS .....</b>	<b>5</b>
Inspection of Delivery .....	5
Manual.....	5
Model Description.....	5
Items Included with Unit.....	6
Initial Setup.....	6
Electrical Requirements .....	6
Before You Plug In Machine.....	7
<b>OPERATING INSTRUCTIONS .....</b>	<b>8</b>
Controls and Their Functions.....	8
Adjusting Temperature Setting.....	9
Operating Instructions.....	9
<b>Care and Cleaning.....</b>	<b>10</b>
Daily Cleaning Instructions for Unit (if equipped).....	10
Crisper/Blower Filters.....	10
Clean the Crisper Compartment .....	10
<b>Troubleshooting .....</b>	<b>12</b>
<b>MAINTENANCE INSTRUCTIONS .....</b>	<b>13</b>
<b>ORDERING SPARE PARTS.....</b>	<b>14</b>
<b>Replacing Broken Glass.....</b>	<b>15</b>
<b>Wire Diagram.....</b>	<b>16</b>
<b>WARRANTY.....</b>	<b>17</b>



# SAFETY PRECAUTIONS



	 <b>DANGER</b>
	<p>Machine must be properly grounded to prevent electrical shock to personnel. Failure to do so could result in serious injury, or death.  <b>DO NOT</b> immerse any part of this equipment in water.  <b>DO NOT</b> use excessive water when cleaning.                  Keep cord and plug off the ground and away from moisture.                  Always unplug the equipment before cleaning or servicing.                  Make sure all machine switches are in the OFF position before plugging the equipment into the receptacle.</p>



	 <b>DANGER</b>
	<p>Improper installation, adjustment, alteration, service, or maintenance can cause property damage, injury, or death. Any alterations to this equipment will void the warranty and may cause a dangerous condition. This appliance is not intended to be operated by means of an external timer or separate remote-control system. <b>NEVER</b> make alterations to this equipment. Read the Installation, Operating, and Maintenance Instructions thoroughly before installing, servicing, or operating this equipment.</p>



	 <b>WARNING</b>
	<p>To avoid burns, <b>DO NOT</b> touch heated surfaces.  <b>DO NOT</b> place or leave objects in contact with heated surfaces.</p>

	 <b>WARNING</b>
	<p><b>ALWAYS</b> wear safety glasses when servicing this equipment.</p>

	 <b>WARNING</b>
	<p>No user serviceable parts inside. Refer servicing to qualified service personnel.</p>

	 <b>WARNING</b>
	<p>Read and understand operator's manual and all other safety instructions before operating this equipment. To order copies of the operator's manual go to <a href="http://www.xfdpopcorn.com">www.xfdpopcorn.com</a> or write to <a href="mailto:XFD/binochen@xfdpopcorn.com">XFD/binochen@xfdpopcorn.com</a></p>

	 <b>WARNING</b>
	DO NOT allow direct contact of this equipment by the public when used in food service locations. Only personnel trained and experienced in the equipment operation may operate this equipment. Carefully read all instructions before operation.

	 <b>WARNING</b>
	This machine is NOT to be operated by minors.

**Note:** Improvements are always being made to XFD's equipment. This information may not be the latest available for your purposes. It is critical that you contact XFD's Technical Service Department for any questions about your machine operations, replacement parts, or any service questions. (XFD XIAMEN MACHINERY AND TECHNOLOGY LTD. does not assume any liability for injury due to careless handling and/or reckless operation of this equipment). General images may be used in manual for reference only.

# INSTALLATION INSTRUCTIONS

## Inspection of Delivery

After unpacking, check thoroughly for any damage which may have occurred during the delivery. Claims should be filed immediately with the transportation company. The warranty does not cover damage that occurs in transit, or damage caused by abuse, or consequential damage due to the operation of this machine, since it's beyond our control (reference warranty in back of manual).

## Manual

Read and understand the operating and safety instructions before operating this equipment. To order copies of the operator's manual go to contact with us.

XFD XIAMEN MACHINERY AND TECHNOLOGY LTD

Contact: Bino Chen

WhatsApp/Skype/Line:+86-15960236006

Tel: 86-592-5701936

Fax: 86-592-5701935

Web: [www.xfdpopcorn.com](http://www.xfdpopcorn.com)

## Model Description

Self-serving Popcorn Dispenser is available for countertop use. Reference descriptions below.

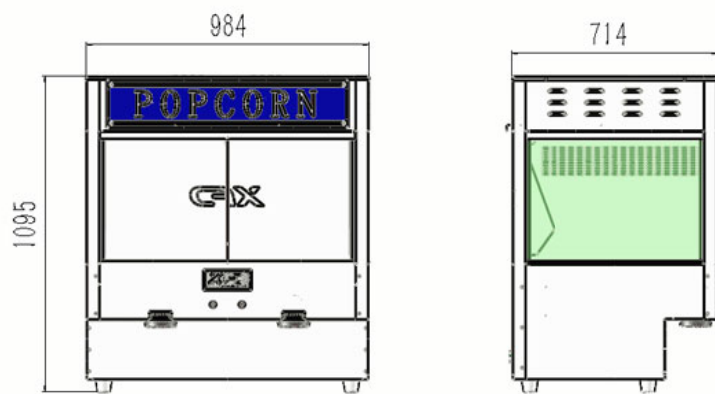

Unit: mm

**ZSX-98:**220V/50Hz/2kW

Countertop Self-serving Popcorn Dispenser, digital control for the popcorn crisping system

(Temperature Controller to adjust heat control).

## Items Included with Unit

 <p style="text-align: center;"><b>Popcorn Scoop</b></p>	
---	--

## Initial Setup

This unit has been tested at the factory.

1. Remove all packaging and tape prior to operation.
2. Modularization design, easy to setup. Place unit on a sturdy, level counter for use.
3. After initial setup, the unit should be cleaned (see Care and Cleaning section of this manual).

## Electrical Requirements

The following power supply must be provided.

**220 V~/50 Hz/ 2kW**

	<p style="text-align: center;"><b>⚠ DANGER</b></p> <p>Machine must be properly grounded to prevent electrical shock to personnel. Failure to do so could result in serious injury, or death.  <b>DO NOT</b> immerse any part of this equipment in water.  <b>DO NOT</b> use excessive water when cleaning.          Keep cord and plug off the ground and away from moisture.          Always unplug the equipment before cleaning or servicing.          Make sure all machine switches are in the OFF position before plugging the equipment into the receptacle.</p>
---	---

A certified electrician must furnish sufficient power for proper machine operation and install any supplied receptacle (reference unit Data Plate for model specific Volts AC, Hertz, and Wattage

requirements). We recommend this equipment be on a dedicated and protected circuit. Failure to wire properly will void the warranty and may result in damage to the machine. It is XFD's recommendation that this machine be plugged directly into a wall outlet. The use of extension cords is not recommended due to safety concerns, and may cause sacrificed and/or reduced performance. Make sure cord is located to prevent a trip hazard or unit upset.

## Before You Plug In Machine

1. Make sure all machine switches are OFF before plugging equipment into receptacle.
2. Make sure wall outlet can accept the grounded plugs (where applicable) on the power supply cord.
3. The wall outlet must have the proper polarity. If in doubt, have a competent electrician inspect the outlet and correct if necessary.
4. **DO NOT** use a grounded to un-grounded receptacle adapter (where applicable).
5. Install unit in a level position.

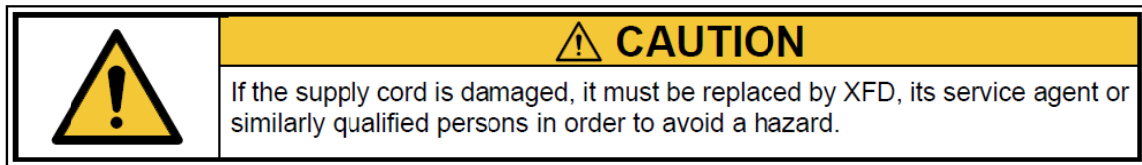

# OPERATING INSTRUCTIONS

## Controls and Their Functions

Unit switches are equipped with an LED light to indicate when there is power to the switch or button.



**Control Panel**



**Customer Side**

### LIGHT BUTTON

Two position, ON/OFF lighted rocker switch - supplies power to the lighting and sign, to the crisper switch, and to the dispense buttons.

### HEAT PRESERVATION BUTTON

Adjusts the temperature of the heating elements for the popcorn crisper from OFF to HIGH.

### TEMPERATURE CONTROLLER

Adjusting the Temperature Setting.

### POPCORN DISPENSE BUTTON

Lighted Push Button Switch – powers the coil assembly for dispensing popcorn. There are two popcorn dispense buttons on the unit. Press and hold a button to dispense popcorn; release button to stop dispensing popcorn.

### 1 AMP FUSE

The topping dispenser pump (if equipped) has a 1 AMP fuse to protect it from an overload condition (lift the corn tray out of the unit to access the fuse, reference the Troubleshooting section).



## Adjusting Temperature Setting

The self-serving popcorn dispenser unit comes from the factory with the Digital Heat Control preset to 55°C (131°F). Follow the steps below to adjust the preset temperature.

1. Turn on the heat preservation switch. After 5s, the temperature controller is on for adjusting.
2. Please press PAR key.
3. When the temperature value flashes, the temperature can be adjusted.
4. Press Left key, reducing the temperature.
5. Press Down key, increasing the temperature.
6. When the temperature reaches the desired value, press Up key.





## Operating Instructions

The self-serving popcorn dispenser unit is easy to use and provides a convenient, sanitary way for customers to self-serve portions of popcorn. Reference instructions below to operate the unit.

1. Turn the Light button ON (this turns the LED display lights ON and supplies power to the popcorn dispense buttons).
2. Put the popcorn cup on the center of the discharging outlet.
3. Draw out the discharging outlet baffles.
4. Press the Dispense Button until desired amount of corn is dispensed.

## Care and Cleaning

	<b>⚠ DANGER</b>
	Machine must be properly grounded to prevent electrical shock to personnel. <b>DO NOT immerse in water.</b> DO NOT clean appliance with a water jet. Always unplug the equipment before cleaning or servicing.

	<b>⚠ WARNING</b>
	To avoid burns, DO NOT touch heated surfaces. DO NOT place or leave objects in contact with heated surfaces.

Good sanitation practice demands that all food preparation equipment be cleaned regularly (only use non-toxic, food grade cleaners). A clean looking, well-kept machine is one of the best ways of advertising your product.

For any cleaning products used, follow the manufacturer's instructions on the product. **DO NOT** use oven cleaners or abrasive materials as they will damage parts of machine.

### Daily Cleaning Instructions for Unit (if equipped)

1. Turn machine OFF, unplug unit and allow it to cool before attempting to clean.
2. Clean all pans/accessories – items may be taken to the sink to clean with soap and water, then rinse and dry.

**To Remove Corn Tray:** Remove any remaining popcorn and lower or remove the drop panel. Slide the coil assembly off each motor shaft, then lift each corn tray out of the unit.

3. Clean under corn pan to remove all popcorn bits and seeds with a vacuum as needed, then wipe the area with a clean dry cloth to remove any grease.

### Crisper/Blower Filters

Clean the Crisper/Blower filters weekly (or as needed) following the instructions below.

### Clean the Crisper Compartment

The blower compartment **MUST** be inspected/cleaned every 3-4 months by Qualified Service Personnel to maintain proper operation.

1. Turn machine OFF, unplug unit and allow it to cool before attempting to clean.
2. Remove the coil assembly and lift off the corn tray to view the blower assembly.

3. Remove the blower cover and if required, carefully clean the blower compartment, and underneath the element with a vacuum only.
4. After cleaning, reassemble blower cover, corn tray, and coil assembly.

## Troubleshooting

Issue	Possible Cause	Solution
<b>No Power to the Unit</b>	A. No Power to the Unit	A. Make sure the Main Power Switch is ON. B. Make sure the Self-serving popcorn dispenser power cord is securely plugged into the wall outlet.
<b>No Popcorn Dispensed</b>	A. Popcorn Dispense Button/Motor B. Coil Assembly not installed correctly C. Dispense Chute	A. Make sure the Main Power Switch is ON to supply power to the Dispense Button. Check if the Dispense Button LED is ON. If the LED is ON, and popcorn does not dispense when the button is pushed, the button or the motor may be faulty, contact qualified service personnel for inspection/repair. B. Coil Assembly not installed correctly, reference Initial Setup section for instructions to properly install coil assembly on motor shaft. C. Make sure the dispense chute opens freely to allow coil assembly to dispense popcorn.
<b>Abnormal Temperature Display</b>	A. Temperature Sensor Failure	A. Replace Temperature Sensor
<b>Abnormal LED Spotlight Display</b>	A. LED Spotlight Failure	A. Replace LED Spotlight
<b>Heat Shuts Off Before Reaching Set Point</b>	A. High Limit B. Heating Pipe Failure	A. Possible high limit issue, contact qualified service personnel for inspection/repair. B. Replace Heating Pipe

# MAINTENANCE INSTRUCTIONS

	<b>⚠ DANGER</b>
	<p>Machine must be properly grounded to prevent electrical shock to personnel. Failure to do so could result in serious injury, or death. DO NOT immerse any part of this equipment in water. DO NOT use excessive water when cleaning. Keep cord and plug off the ground and away from moisture. Always unplug the equipment before cleaning or servicing. Make sure all machine switches are in the OFF position before plugging the equipment into the receptacle.</p>

	<b>⚠ DANGER</b>
	<p>Improper installation, adjustment, alteration, service, or maintenance can cause property damage, injury, or death. Any alterations to this equipment will void the warranty and may cause a dangerous condition. This appliance is not intended to be operated by means of an external timer or separate remote-control system. NEVER make alterations to this equipment. Read the Installation, Operating, and Maintenance Instructions thoroughly before installing, servicing, or operating this equipment.</p>

	<b>⚠ WARNING</b>
	<p>No user serviceable parts inside. Refer servicing to qualified service personnel.</p> <p style="text-align: right;">011 051514</p>

	<b>⚠ CAUTION</b>
	<p>THE FOLLOWING SECTIONS OF THIS MANUAL ARE INTENDED ONLY FOR QUALIFIED SERVICE PERSONNEL WHO ARE FAMILIAR WITH ELECTRICAL EQUIPMENT. THESE ARE NOT INTENDED FOR THE OPERATOR.</p> <p style="text-align: right;">027 010914</p>

## ORDERING SPARE PARTS

<b>Recommended Spare Parts</b>			
Description	Quantity (pcs)	Unit Price (USD)	Remark
Spot Light	1 pcs	43	Including an voltage transformer
Heating Tube	1 pcs	73.5	

1. Identify the needed part by checking it against the photos, illustrations, and/or parts list. (General images may be used in manual for reference only.)
2. Use only approved replacement parts when servicing this unit.
3. When ordering, please include part number, part name, and quantity needed.
4. Please include your model number and date of manufacture (located on the machine nameplate/data plate) with your order.

5. Address all parts orders to Sales Department,  
XFD XIAMEN MACHINERY AND TECHNOLOGY LTD

Contact: Bino Chen

WhatsApp/Skype/Line: +86-15960236006

Tel: 86-592-5701936

Fax: 86-592-5701935

Web: [www.xfdpopcorn.com](http://www.xfdpopcorn.com)

---

## Replacing Broken Glass

Broken glass panels can be easily replaced. XFD does not ship glass. It can be obtained from a local glass shop and always purchase tempered glass.

GLASS DIMENSIONS (Height x Width x Thickness)

Front Glass: 884\*443\*4mm

Side Glass: 614\*368\*4mm (2Pieces)

1. Turn machine OFF, unplug unit and allow it to cool before attempting to replace glass.
2. Remove all loose pieces of broken glass.
3. Pull out Magnetic Clip located above glass panel in cabinet interior (see image below).  
The magnetic clip is used for shipping purposes, to hold glass in place during transit.
4. Remove all rigid glass channels from around glass to be replaced; set channels aside for reuse.
5. Carefully remove the rest of the broken glass.
6. Apply decals (if desired) to new glass panel.
7. Slide rigid glass channels over the exposed sides and bottom of new glass panel.
8. Carefully slide glass panel up under top ridge, then lower into the bottom channel.

# Wire Diagram

## Model No. ZSX-98

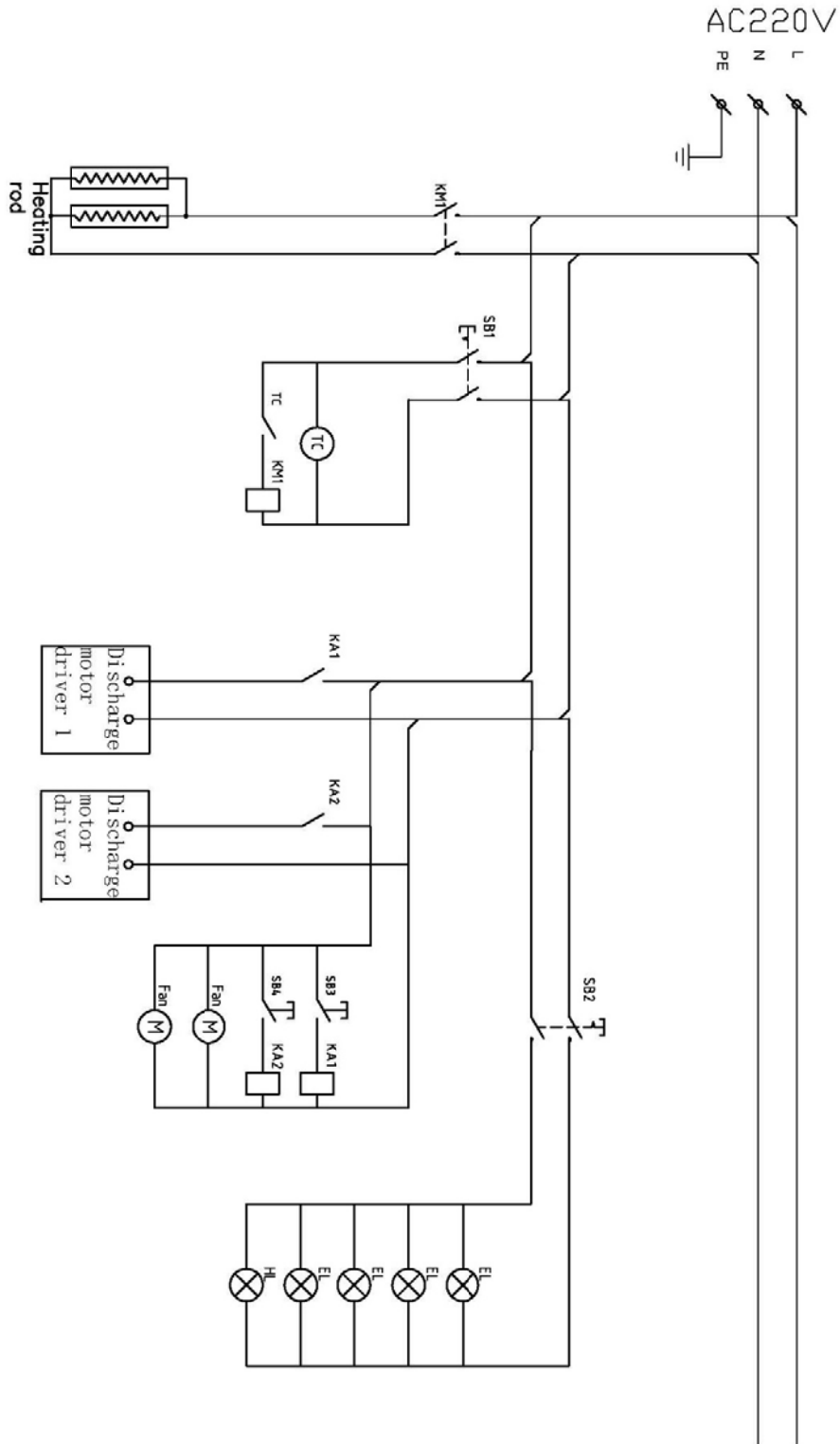



---

## WARRANTY

XFD warrants to the original purchaser each item of its manufacture to be free of defects in workmanship and material under normal use and service. XFD 's obligation under this warranty is limited solely to repairing or replacing parts. The warranty applies for a period of one (1) years from the date of original sale to the original purchaser of equipment when recommended operating instructions and maintenance procedures have been followed. These are packed with the machine. Parts warranty is one (1) years, labor is six (6) months.

THIS WARRANTY IS IN LIEU OF ALL OTHER WARRANTIES EXPRESSED OR IMPLIED, AND OF ALL OTHER OBLIGATIONS OR LIABILITIES ON OUR PART, INCLUDING THE IMPLIED WARRANTY OF MERCHANTABILITY. THERE ARE NO WARRANTIES WHICH EXTEND BEYOND THE DESCRIPTION ON THE FACE HEREOF.

In no event shall XFD be liable for special, incidental or consequential damages. No claim under this warranty will be honored if the equipment covered has been misused, neglected, damaged in transit, or has been tampered with or changed in any way. No claim under this warranty shall be honored in the event that components in the unit at the time of the claim were not supplied or approved by XFD This warranty is effective only when electrical items have been properly attached to city utility lines only at proper voltages. This warranty is not transferable without the written consent of XFD.

The term "Original Purchaser" as used in this warranty shall be deemed to mean that person, firm, association, or corporation who was billed by the XFD, or their authorized distributor for the equipment.

THIS WARRANTY HAS NO EFFECT AND IS VOID UNLESS THE ORIGINAL PURCHASER FIRST CALLS XFD AT 86-592-570-1936 TO DISCUSS WITH OUR SERVICE REPRESENTATIVE THE EQUIPMENT PROBLEM, AND, IF NECESSARY, FOR INSTRUCTIONS CONCERNING THE REPAIR OR REPLACEMENT OF PARTS.

*NOTE: This equipment is manufactured and sold for commercial use only.*

© 2021 – The text, descriptions, graphics, layout, and other material in this publication are the exclusive property of XFD and shall not be used, copied, reproduced, or published in any fashion, including website display, without its express written consent.